

Power



RD30 Power

RD30 Power

Kabelsteckverbinder

- Schraubverriegelung RD30
- 5- (4+PE), 13- (12+PE) und 24-polig
- Schutzart IP65 ¹⁾
- Löt-/Schraubklemmanschluss
- Durchmesser 40 mm
- Varianten mit VDE-, SEV-Zulassung

Flanschsteckverbinder

- Schraubverriegelung RD30
- 5- (4+PE), 13- (12+PE) und 24-polig
- Schutzart IP65 ¹⁾
- Löt-/Schraubklemmanschluss
- Flansch 44,45 x 44,45 mm
- Varianten mit VDE-, SEV-Zulassung

Cable Connectors

- Screw termination RD30
- 5 (4+PE), 13 (12+PE) and 24 contacts
- Degree of protection IP65 ¹⁾
- Solder/screw clamp termination
- Diameter 40 mm
- Variants with VDE-, SEV-approval

Panel Mount Connectors

- Screw termination RD30
- 5 (4+PE), 13 (12+PE) and 24 contacts
- Degree of protection IP65 ¹⁾
- Solder/screw clamp termination
- Panel mount connectors 44.45 x 44.45 mm
- Variants with VDE-, SEV-approval

¹⁾Erläuterung der Schutzarten siehe technische Informationen./ ¹⁾Explanation of protection standards see technical information.

Kabelstecker
Male cable connector

Abbildung / Figure



Winkelstecker
Male angled connector



Maßzeichnung / Drawing

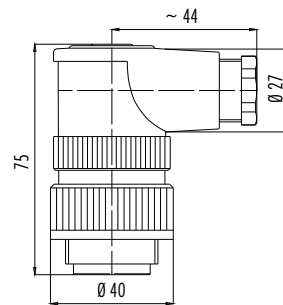
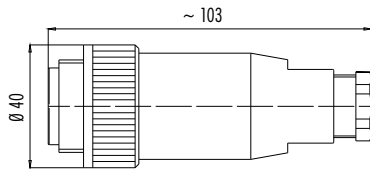

Bestell-Daten / Order Data

Polzahl Contacts	Kabeldurchlass Cable outlet	Bestell-Nr. Ordering-No.	
4+PE	10–12 mm	99 0709 00 05	
	12–14 mm	99 0709 02 05	
	14–18 mm	99 0709 03 05	
12+PE	10–12 mm	99 0717 00 13	
	12–14 mm	99 0717 02 13	
	14–18 mm	99 0717 03 13	
24	10–12 mm	99 0737 00 24	
	12–14 mm	99 0737 02 24	
	14–18 mm	99 0737 03 24	

Polzahl Contacts	Kabeldurchlass Cable outlet	Bestell-Nr. Ordering-No.	
4+PE	10–12 mm	99 0709 70 05	
	12–14 mm	99 0709 72 05	
	14–18 mm	99 0709 73 05	
12+PE	10–12 mm	99 0717 70 13	
	12–14 mm	99 0717 72 13	
	14–18 mm	99 0717 73 13	
24	10–12 mm	99 0737 70 24	
	12–14 mm	99 0737 72 24	
	14–18 mm	99 0737 73 24	

Technische Daten / Specifications

Polzahl	4+PE	12+PE	24	Number of contacts
Steckverbinder Verriegelung	schrauben/screw			Connector locking system
Anschlussart	löten/solder			Termination
Anschlussquerschnitt	max. 2,5 mm ² (max. AWG 14)	max. 1,0 mm ² (max. AWG 18)	max. 0,25 mm ² (max. AWG 24)	Wire gauge
Kabeldurchlass	10–12 mm, 12–14 mm, 14–18 mm			Cable outlet
Schutzart	IP65			Degree of protection
Mechanische Lebensdauer	> 500 Steckzyklen/> 500 mating cycles			Mechanical operation
Obere Grenztemperatur	+ 100 °C			Upper temperature
Untere Grenztemperatur	– 40 °C			Lower temperature
Bemessungsspannung	400 V	250 V	125 V	Rated voltage
Bemessungs-Stoßspannung	6000 V	4000 V	2500 V	Rated impulse voltage
Verschmutzungsgrad	3			Pollution degree
Überspannungskategorie	III			Overvoltage categorie
Isolierstoffgruppe	III			Material group
Bemessungsstrom (40 °C)	20 A	6 A	3 A	Rated current (40 °C)
Durchgangswiderstand	≤ 5 mΩ			Contact resistance
Material Kontakt	CuZn (Messing/brass)			Material of contact
Kontaktoberfläche	Ag (Silber/silver)		Au (Gold/gold)	Contact plating
Material Kontaktkörper	PA			Material of contact body
Material Gehäuse	PA			Material of housing

Kabeldose
Female cable connector

Abbildung / Figure



Winkeldose
Female angled connector



Maßzeichnung / Drawing

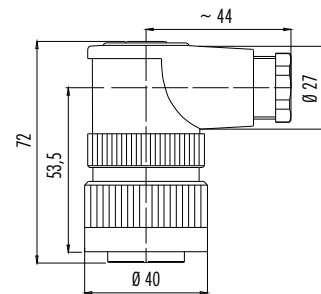
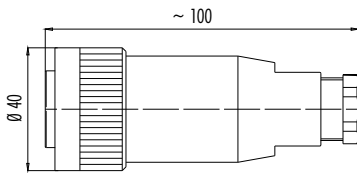

Bestell-Daten / Order Data

Polzahl Contacts	Kabeldurchlass Cable outlet	Bestell-Nr. Ordering-No.	
4+PE	10–12 mm	99 0710 00 05	
	12–14 mm	99 0710 02 05	
	14–18 mm	99 0710 03 05	
12+PE	10–12 mm	99 0718 00 13	
	12–14 mm	99 0718 02 13	
	14–18 mm	99 0718 03 13	
24	10–12 mm	99 0738 00 24	
	12–14 mm	99 0738 02 24	
	14–18 mm	99 0738 03 24	

Polzahl Contacts	Kabeldurchlass Cable outlet	Bestell-Nr. Ordering-No.	
4+PE	10–12 mm	99 0710 70 05	
	12–14 mm	99 0710 72 05	
	14–18 mm	99 0710 73 05	
12+PE	10–12 mm	99 0718 70 13	
	12–14 mm	99 0718 72 13	
	14–18 mm	99 0718 73 13	
24	10–12 mm	99 0738 70 24	
	12–14 mm	99 0738 72 24	
	14–18 mm	99 0738 73 24	

Technische Daten / Specifications

Polzahl	4+PE	12+PE	24	Number of contacts
Steckverbinder Verriegelung	schrauben/screw			Connector locking system
Anschlussart	löten/solder			Termination
Anschlussquerschnitt	max. 2,5 mm ² (max. AWG 14)	max. 1,0 mm ² (max. AWG 18)	max. 0,25 mm ² (max. AWG 24)	Wire gauge
Kabeldurchlass	10–12 mm, 12–14 mm, 14–18 mm			Cable outlet
Schutzart	IP65			Degree of protection
Mechanische Lebensdauer	> 500 Steckzyklen/> 500 mating cycles			Mechanical operation
Oberer Grenztemperatur	+ 100 °C			Upper temperature
Untere Grenztemperatur	– 40 °C			Lower temperature
Bemessungsspannung	400 V	250 V	125 V	Rated voltage
Bemessungs-Stoßspannung	6000 V	4000 V	2500 V	Rated impulse voltage
Verschmutzungsgrad	3			Pollution degree
Überspannungskategorie	III			Overvoltage categorie
Isolierstoffgruppe	III			Material group
Bemessungsstrom (40°C)	20 A	6 A	3 A	Rated current (40 °C)
Durchgangswiderstand	≤ 5 mΩ			Contact resistance
Material Kontakt	CuSn (Bronze/bronze)			Material of contact
Kontaktoberfläche	Ag (Silber/silver)		Au (Gold/gold)	Contact plating
Material Kontaktkörper	PA			Material of contact body
Material Gehäuse	PA			Material of housing

Montageanleitung
Assembly instruction

1. Winkelkappe, Winkelhülse, Dichtung, Klemmkorb und Druckschraube auffädeln.
2. Kontakteinsatz in Gehäuse einclipen.
3. Leiter abmanteln, abisolieren und anschließen.
4. Winkelhülse mit vormontiertem Gehäuse bis zum mechanischen Anschlag fest verschrauben.
5. Teile gemäß Darstellung montieren.

1. Bead angled hood, sleeve, seal, pinch ring and pressing screw.
2. Clip contact insert into housing.
3. Dismantle cable, strip wire and contact wires.
4. Strongly fasten angled sleeve with preassembled housing up to mechanical stop.
5. Mount remaining parts according to figure.

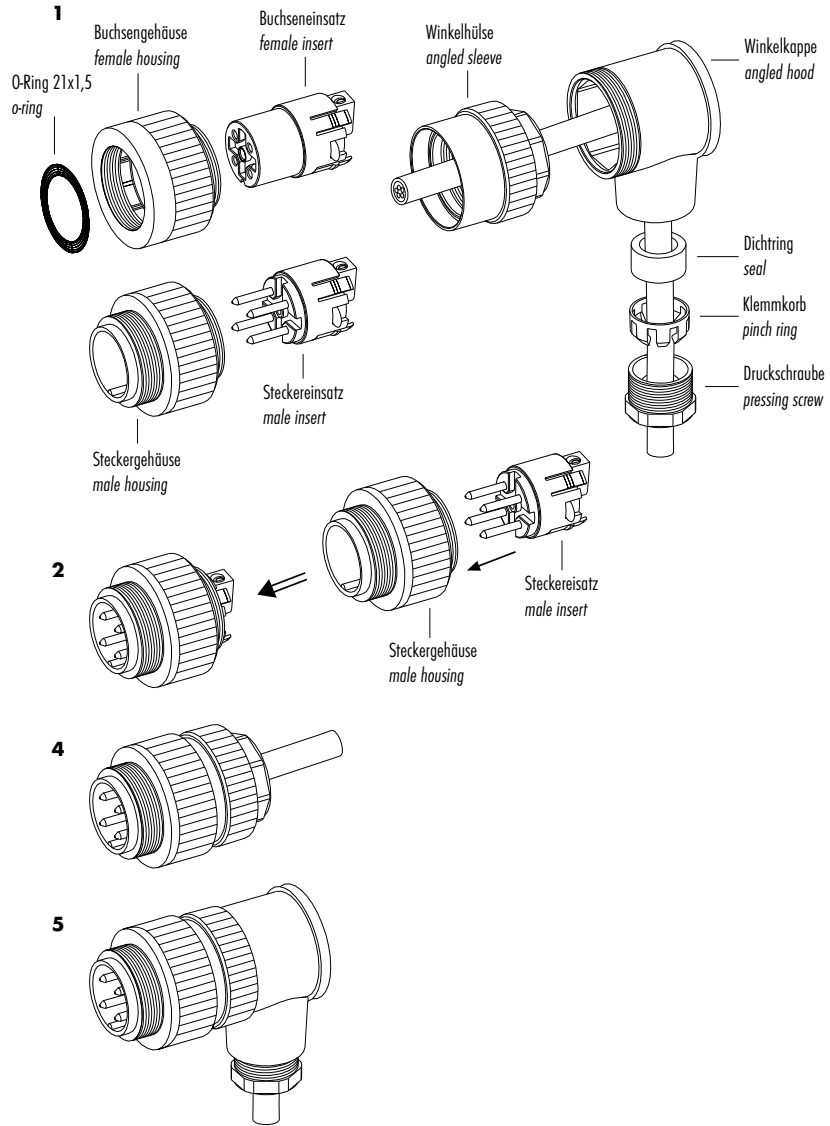

Einzelteildarstellung
Component part drawing

Kabelsteckverbinder
Cable connectors

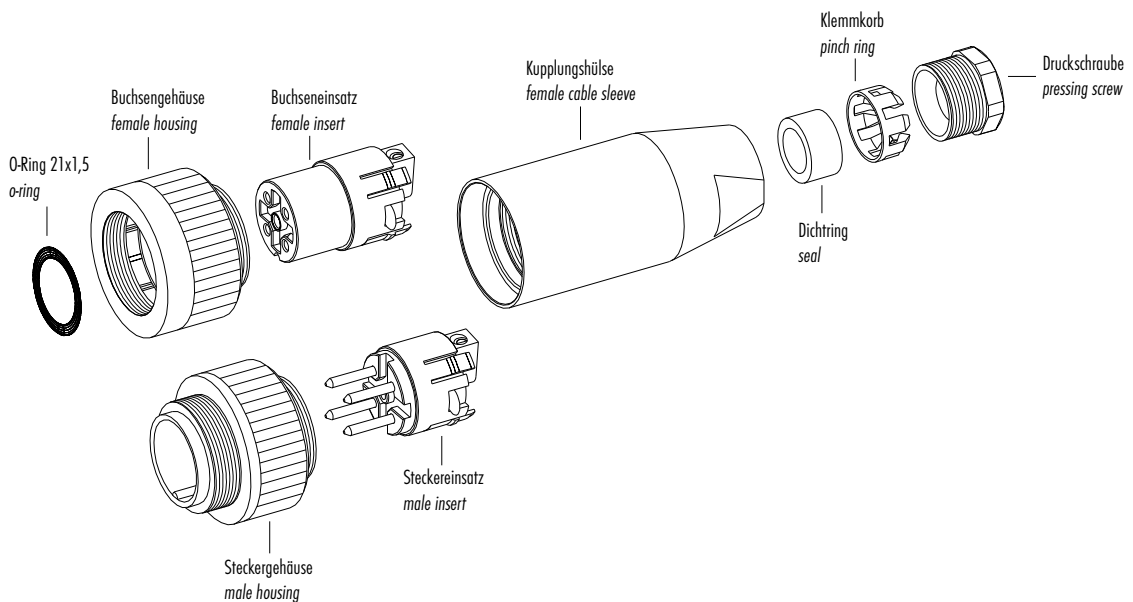

Flanschstecker
Male panel mount connector

Abbildung / Figure



Flanschdose
Female panel mount connector



Maßzeichnung / Drawing

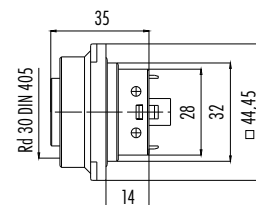
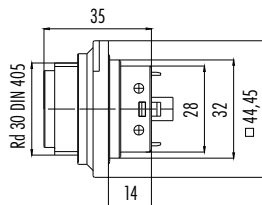

Bestell-Daten / Order Data

Polzahl Contacts	Bestell-Nr. Ordering-No.
4+PE	99 0711 00 05
12+PE	99 0719 00 13
24	99 0739 00 24

Polzahl Contacts	Bestell-Nr. Ordering-No.
4+PE	99 0712 00 05
12+PE	99 0720 00 13
24	99 0740 00 24

Technische Daten / Specifications

Polzahl	4+PE	12+PE	24	Number of contacts
Steckverbinder Verriegelung	schrauben/screw			Connector locking system
Anschlussart	löten/solder			Termination
Anschlussquerschnitt	max. 2,5 mm ² (max. AWG 14)	max. 1,0 mm ² (max. AWG 18)	max. 0,25 mm ² (max. AWG 24)	Wire gauge
Kabeldurchlass	—			Cable outlet
Schutzart	IP65			Degree of protection
Mechanische Lebensdauer	> 500 Steckzyklen/> 500 mating cycles			Mechanical operation
Oberer Grenztemperatur	+ 100 °C			Upper temperature
Untere Grenztemperatur	- 40 °C			Lower temperature
Bemessungsspannung	400 V	250 V	125 V	Rated voltage
Bemessungs-Stoßspannung	6000 V	4000 V	2500 V	Rated impulse voltage
Verschmutzungsgrad	3			Pollution degree
Überspannungskategorie	III			Overvoltage categorie
Isolierstoffgruppe	III			Material group
Bemessungsstrom (40°C)	20 A	6 A	3 A	Rated current (40 °C)
Durchgangswiderstand	≤ 5 mΩ			Contact resistance
Material Kontakt	Stift/pin CuZn (Messing/brass), Buchse/socket CuSn (Bronze/bronze)			Material of contact
Kontaktoberfläche	Ag (Silber/silver)		Au (Gold/gold)	Contact plating
Material Kontaktkörper	PA			Material of contact body
Material Gehäuse	PA			Material of housing

694

Polbilder
Contact arrangements

Stifteinsatz (Steckseite)
Male insert (mating side)

Buchseinsatz (Steckseite)
Female insert (mating side)

4+PE pol
4+PE contacts

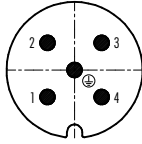

	X	Y
1	-4,77	-4,77
2	-4,77	4,77
3	4,77	4,77
4	4,77	-4,77
⊕	0,00	0,00

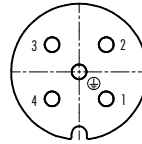

	X	Y
1	4,77	-4,77
2	4,77	4,77
3	-4,77	4,77
4	-4,77	-4,77
⊕	0,00	0,00

12+PE pol
12+PE contacts

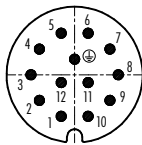

	X	Y
1	-2,38	-7,33
2	-6,23	-4,53
3	-7,70	0,00
4	-6,23	4,53
5	-2,38	7,33
6	2,38	7,33
7	6,23	4,53
8	7,70	0,00
9	6,23	-4,53
10	2,38	-7,33
11	2,38	-1,37
12	-2,38	-1,37
⊕	0,00	2,74

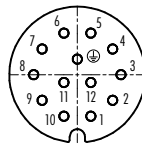

	X	Y
1	2,38	-7,33
2	6,23	-4,53
3	7,70	0,00
4	6,23	4,53
5	2,38	7,33
6	-2,38	7,33
7	-6,23	4,53
8	-7,70	0,00
9	-6,23	-4,53
10	-2,38	-7,33
11	-2,38	-1,37
12	2,38	-1,37
⊕	0,00	2,74

24 pol
24 contacts

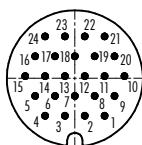

	X	Y
1	5,25	-6,60
2	1,75	-6,60
3	-1,75	-6,60
4	-5,25	-6,60
5	-7,00	-3,10
6	-3,50	-3,10
7	0,00	-3,10
8	3,50	-3,10
9	7,00	-3,10
10	8,75	0,40
11	5,25	0,40
12	1,75	0,40
13	-1,75	0,40
14	-5,25	0,40
15	-8,75	0,40
16	-7,00	3,90
17	-3,50	3,90
18	0,00	3,90
19	3,50	3,90
20	7,00	3,90
21	5,25	7,40
22	1,75	7,40
23	-1,75	7,40
24	-5,25	7,40

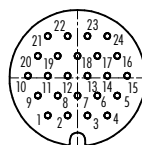

	X	Y
1	-5,25	-6,60
2	-1,75	-6,60
3	1,75	-6,60
4	5,25	-6,60
5	7,00	-3,10
6	3,50	-3,10
7	0,00	-3,10
8	-3,50	-3,10
9	-7,00	-3,10
10	-8,75	0,40
11	-5,25	0,40
12	-1,75	0,40
13	1,75	0,40
14	5,25	0,40
15	8,75	0,40
16	7,00	3,90
17	3,50	3,90
18	0,00	3,90
19	-3,50	3,90
20	-7,00	3,90
21	-5,25	7,40
22	-1,75	7,40
23	1,75	7,40
24	5,25	7,40

Montageausschnitt
Panel cut out

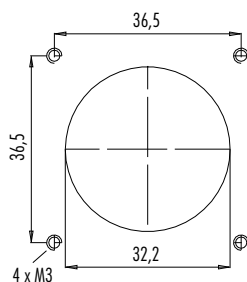

Kennlinie
Rating

Strombelastbarkeitskurve
Derating curve

