

- Snap-in locking system
- 3 – 12 contacts
- Degree of protection IP67
- Solder termination
- Moulded versions
- Diameter 16 mm
- Coloured versions



Description

Male cable connector



Drawing

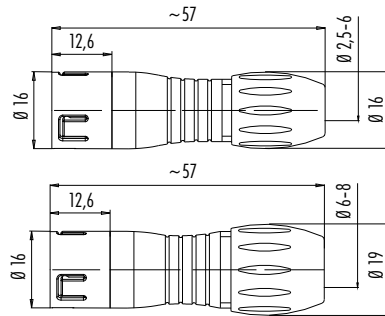

Contacts	Cable-Ø 2,5–4 mm	Cable-Ø 4–6 mm	Cable-Ø 6–8 mm
3	99 9105 03 03	99 9105 00 03	99 9105 02 03
5	99 9113 03 05	99 9113 00 05	99 9113 02 05
8	99 9125 03 08	99 9125 00 08	99 9125 02 08
12	99 9133 03 12	99 9133 00 12	99 9133 02 12

Male cable connector, red, blue, green



	Cable outlet	Red	Blue	Green
3		99 9105 50 03	99 9105 60 03	99 9105 70 03
5	4–6 mm	99 9113 50 05	99 9113 60 05	99 9113 70 05
8		99 9125 50 08	99 9125 60 08	99 9125 70 08
12	6–8 mm	99 9133 52 12	99 9133 62 12	99 9133 72 12

Female cable connector

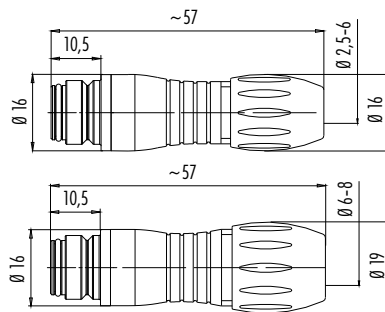

Contacts	Cable-Ø 2,5–4 mm	Cable-Ø 4–6 mm	Cable-Ø 6–8 mm
3	99 9106 03 03	99 9106 00 03	99 9106 02 03
5	99 9114 03 05	99 9114 00 05	99 9114 02 05
8	99 9126 03 08	99 9126 00 08	99 9126 02 08
12	99 9134 03 12	99 9134 00 12	99 9134 02 12

Female cable connector, red, blue, green



	Cable outlet	Red	Blue	Green
3		99 9106 50 03	99 9106 60 03	99 9106 70 03
5	4–6 mm	99 9114 50 05	99 9114 60 05	99 9114 70 05
8		99 9126 50 08	99 9126 60 08	99 9126 70 08
12	6–8 mm	99 9134 52 12	99 9134 62 12	99 9134 72 12

Specifications

Contacts	3	5	8	12
Wire gauge	max. 0,75 mm ² (max. AWG 20)		max. 0,25 mm ² (max. AWG 24)	
Mechanical operation	> 500 Mating cycles			
Temperature range	– 25 °C / + 85 °C			
Rated voltage	250 V	125 V	60 V	
Pollution degree	2			
Rated current (40°C)	7 A	5 A	2 A	
Contact plating	Au (Gold)			
Material of housing	PA			

Description

Male cable connector, moulded



Drawing

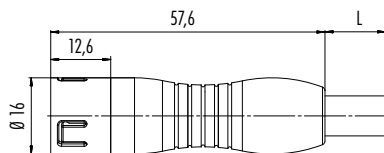

Contacts

3 x 0,75
5 x 0,75
8 x 0,25
12 x 0,25

Cable length, PVC

2 m

Ordering-No.

79 9149 020 03
79 9157 020 05
79 9169 020 08
79 9177 020 12

Female cable connector, moulded

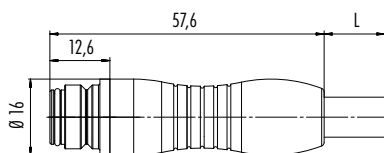

3 x 0,75
5 x 0,75
8 x 0,25
12 x 0,25

2 m

79 9150 020 03
79 9158 020 05
79 9170 020 08
79 9178 020 12

Male panel mount connector, solder termination

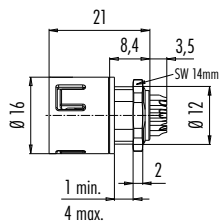

Black

3 99 9107 00 03
5 99 9115 00 05
8 99 9127 00 08
12 99 9135 00 12

Male panel mount connector, solder termination



Red

Blue

Green

3	99 9107 50 03	99 9107 60 03	99 9107 70 03
5	99 9115 50 05	99 9115 60 05	99 9115 70 05
8	99 9127 50 08	99 9127 60 08	99 9127 70 08
12	99 9135 50 12	99 9135 60 12	99 9135 70 12

Male panel mount connector, dip-solder termination

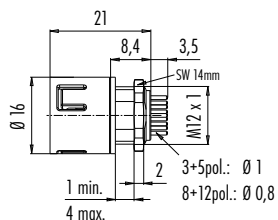

Black

3 99 9107 090 03
5 99 9115 090 05
8 99 9127 090 08
12 99 9135 090 12

Female panel mount connector, solder termination

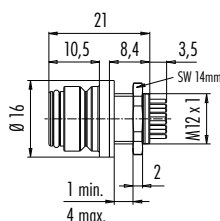

3 99 9108 00 03
5 99 9116 00 05
8 99 9128 00 08
12 99 9136 00 12

Description

Drawing

Contacts

Red

Blue

Green

Female panel mount connector, solder termination

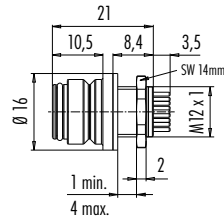

3	99 9108 50 03	99 9108 60 03	99 9108 70 03
5	99 9116 50 05	99 9116 60 05	99 9116 70 05
8	99 9128 50 08	99 9128 60 08	99 9128 70 08
12	99 9136 50 12	99 9136 60 12	99 9136 70 12

Black

Female panel mount connector, dip-solder termination

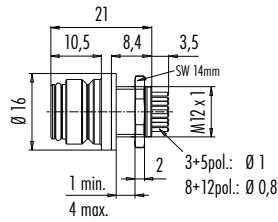

3	99 9108 090 03		
5	99 9116 090 05		
8	99 9128 090 08		
12	99 9136 090 12		

Ordering-No.

Adapter for panel mount connectors

08 2433 000 001

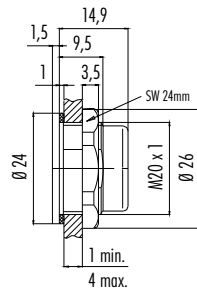

Adapter for panel mount connectors, front fastened

08 2434 000 001

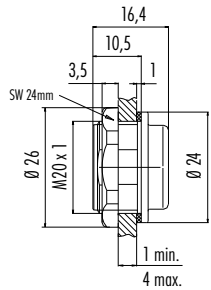

Component part drawing

Cable connectors

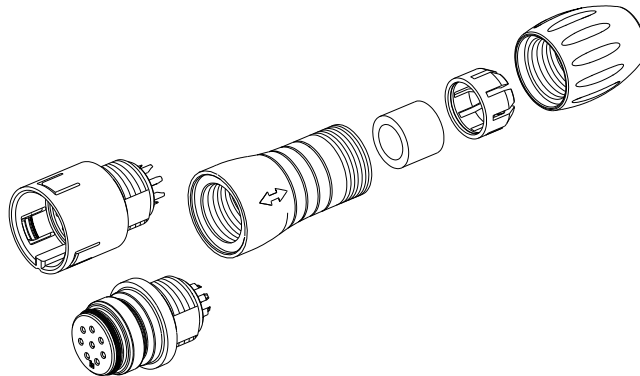

- Male insert
- Female insert
- Sleeve
- Seal
- Pinch ring
- Pressing screw

Panel mount connectors

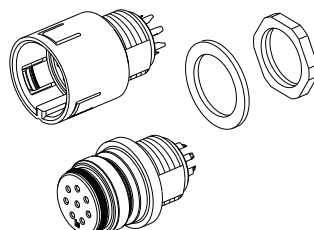

- Male insert
- Female insert
- Flat seal
- Hexagonal nut

Component part drawing

Assembly Adapter

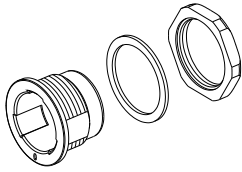

Adapter
Flat seal
Hexagonal nut

Assembly Adapter, front fastened

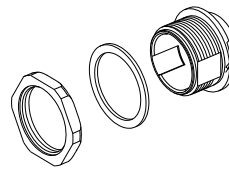

Hexagonal nut
Flat seal
Adapter

Contact arrangements male insert (mating side)

3 contacts

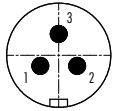

5 contacts

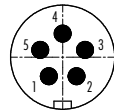

8 contacts

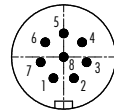

12 contacts

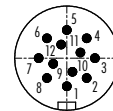

Contact arrangements female insert (mating side)

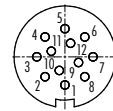
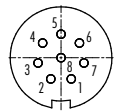
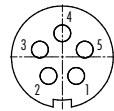
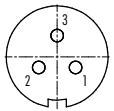

Panel cut out

Panel mount connectors

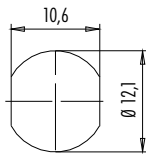

Adapter

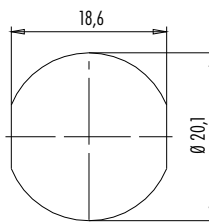

Colour of wire, moulded cable connectors

- | | |
|----------|--------------|
| 1 white | 7 blue |
| 2 brown | 8 red |
| 3 green | 9 black |
| 4 yellow | 10 purple |
| 5 grey | 11 grey/pink |
| 6 pink | 12 red/blue |

Description

Protection cap for male cable connector



Drawing

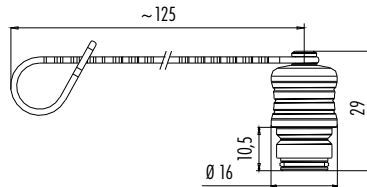

Ordering-No.

08 2587 000 000

Protection cap for female cable connector

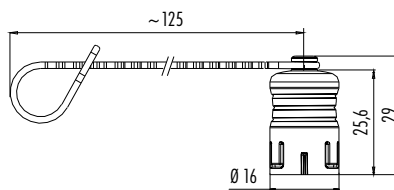

08 2586 000 000

Protection cap for male panel mount connector

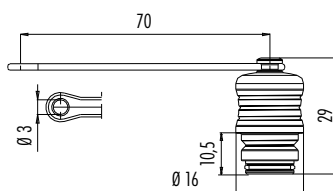

Hole-Ø D

Hole-Ø D	Ordering-No.
3 mm	08 2559 000 000
12 mm	08 2680 000 000
20 mm	08 2674 000 000

Protection cap for male panel mount connector

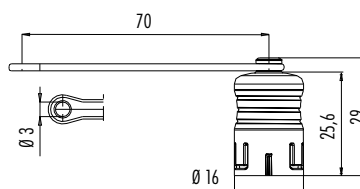

3 mm	08 2567 000 000
12 mm	08 2681 000 000
20 mm	08 2675 000 000